

XG

- Characteristics
- wide range of forces and ratings
 - long mechanical and electrical life
 - solder, faston, PCB
 - compliant to IEC 60335-1, 4. ed.

Rating 250 VAC, 26 A max.

Dimensions (mm) 27,8 × 15,9 × 10,3

- Actuator
- plunger
 - plain levers
 - roller levers
 - simulated roller levers

Approvals ENEC, UL, cUL, CSA

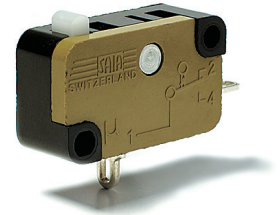

Preferred Range

Ordering Reference	Actuating Force		Operating pos.		Terminal	Circuit	Actuator	Contacts	Electrical rating	
	(N)	(ozf)	(mm)	(in)					ENEC	UL/CSA
XGG2-88Z1	3,20	11,43	14,7	0,57	Faston	CO	Plunger	Ag / AgNi10	16(6) A	15 A
XGG2-88-J23Z1	1,40	5,03	14,9	0,59	Faston	CO	Plain lever	Ag / AgNi10	16(6) A	15 A
XGG2-88-J26Z1	0,91	3,27	14,5	0,57	Faston	CO	Plain lever	Ag / AgNi10	16(6) A	15 A
XGG2-88-J27Z1	0,65	2,34	13,7	0,54	Faston	CO	Plain lever	Ag / AgNi10	16(6) A	15 A
XGG2-88-S20Z1	3,20	11,43	20,2	0,79	Faston	CO	Roller lever	Ag / AgNi10	16(6) A	15 A
XGG2-88-S21Z1	1,55	5,57	20,1	0,79	Faston	CO	Roller lever	Ag / AgNi10	16(6) A	15 A
XGG3-88Z1	3,20	11,43	14,7	0,57	Solder	CO	Plunger	Ag / AgNi10	16(6) A	15 A
XGG6-88Z1	3,20	11,43	14,7	0,57	Faston	CO	Plunger	Ag / AgNi10	16(6) A	15 A
XGC2-88Z1	0,80	2,86	14,7	0,57	Faston	CO	Plunger	Ag / AgNi10	12(6) A	10 A
XGC2-88-J23Z1	0,35	1,26	15,0	0,59	Faston	CO	Plain lever	Ag / AgNi10	12(6) A	10 A
XGC2-88-S20Z1	0,80	2,86	20,2	0,79	Faston	CO	Roller lever	Ag / AgNi10	12(6) A	10 A
XGC6-88Z1	0,80	2,86	14,7	0,57	Faston	CO	Plunger	Ag / AgNi10	12(6) A	10 A
XGK2-88Z1	1,50	5,36	14,7	0,57	Faston	CO	Plunger	Ag / AgNi10	12(6) A	12 A
XGK2-88-J26Z1	0,43	1,55	14,7	0,57	Faston	CO	Plain lever	Ag / AgNi10	12(6) A	12 A
XGK2-88-S21Z1	0,71	2,55	20,2	0,80	Faston	CO	Roller lever	Ag / AgNi10	12(6) A	12 A
XGK3-88Z1	1,50	5,36	14,7	0,57	Solder	CO	Plunger	Ag / AgNi10	12(6) A	12 A
XGK6-88Z1	1,50	5,36	14,7	0,57	Faston	CO	Plunger	Ag / AgNi10	12(6) A	12 A
XG02-88Z1	1,20	4,29	14,5	0,57	Faston	CO	Plunger	Ag / AgNi10	16(6) A	15 A
XG02-88-J27Z1	0,25	0,90	13,6	0,54	Faston	CO	Plain lever	Ag / AgNi10	16(6) A	15 A
XG02-88-S20Z1	1,20	4,29	20,1	0,79	Faston	CO	Roller lever	Ag / AgNi10	16(6) A	15 A
XG06-88Z1	1,20	4,29	14,5	0,57	Faston	CO	Plunger	Ag / AgNi10	16(6) A	15 A

Specifications

Housing	Melamine-Formaldehyd. Thermosetting
Plunger	POM, PPS, MF depending on temperature/type
Mechanism	Snap-action, single pole beryllium bronze blade mechanism with wiping contacts
Functions	Change-over, normally-closed (except XGG and XGK) or normally-open
Contacts	Fine silver (Ag), silver nickel (AgNi10), gold-plated (Au), silver cadmium oxide (AgCdO)
Terminals	Solder, faston, PCB and side mounting PCB terminals. RAST 5 terminals (5,0 mm pitch)
Temperature range °C	-40°C to +150°C
Mechanical life	2 x 10 ⁵ cycles minimum, 5 x 10 ⁶ cycles maximum (Actuation: sinusoidal and maximum up to 80% of the overtravel)
Protection	Enclosure IP40
Mounting	Side mounting via mounting holes
Actuators	Stainless steel

Circuit diagram

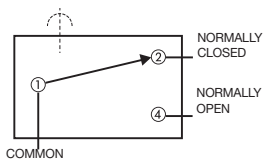

Actuating force/travel

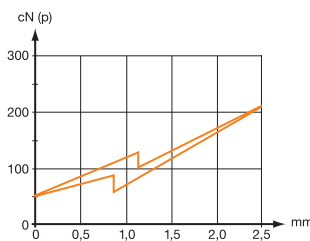

Contact force/travel

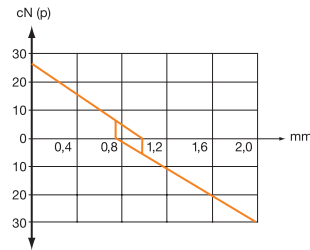

Dimensions

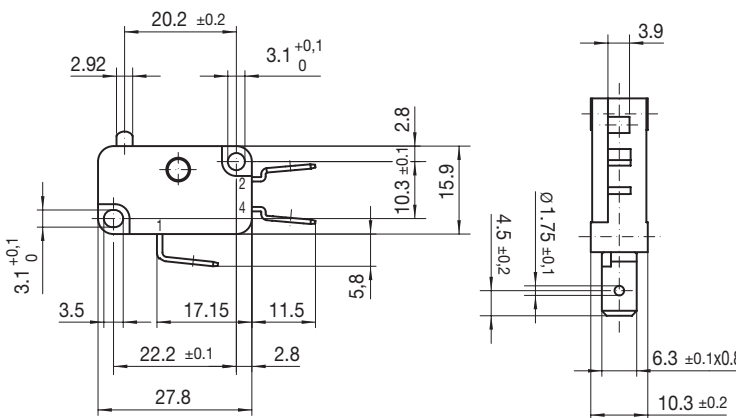

Maximum DC rating

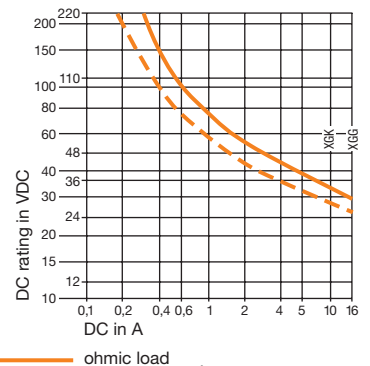

Recommended maximum electrical ratings

	Voltage (VAC)	Approvals ENEC	UL	(VAC)		Voltage (VAC)	Approvals ENEC	UL	(VAC)		
XGG...-88	250	16 (6)	5E4	15 A	125/250	XGT...-86	250	26 (10)	25E3	25A	125/250
XGA...-88	250	16 (6)	5E4	15 A	125/250	XGD...-86	250	22 (6)	5E4	21A	125/250
XGM...-88	250	16 (6)	5E4	15 A	125/250	XGA...-86	250	20 (8)	5E4	15A	125/250
XGO...-88	250	16 (6)	5E4	15 A	125/250	XGM...-86	250	20 (8)	5E4	15A	125/250
XGB...-88	250	12 (6)	5E4	12 A	125/250	XGO...-86	250	20 (8)	5E4	15A	125/250
XGC...-88	250	12 (6)	5E4	10 A	125/250	XGA...-86	400	10 (6)	5E4	-	-
XGH...-88	250	12 (6)	5E4	10 A	125/250	XGG...-86	400	10 (6)	5E4	-	-
XGK...-88	250	12 (6)	5E4	12 A	125/250	XGM...-86	400	10 (6)	5E4	-	-
XG....-88	400	3 (2)	5E4			XGO...-86	400	10 (6)	5E4	-	-

Operating Characteristics

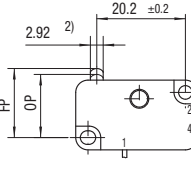
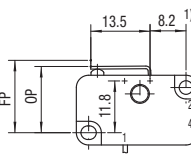
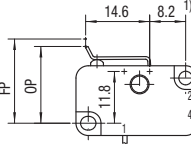
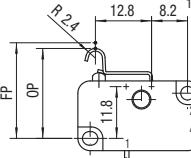
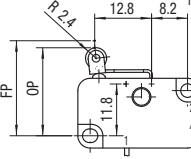
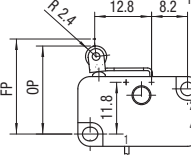
Actuator	Reference	Actuating Force		Release Force		Free Position FP		Operating Position OP		Movement Differential		Total travelled position		
		Maximum (N)	(ozf)	Minimum (N)	(ozf)	Maximum (mm)	(in)	(mm)	(in)	Maximum (mm)	(in)	(mm)	(in)	
	XGG..	3,2	11,43	0,4	1,43	15,75	0,62	14,7	$\left. \begin{array}{l} 0,57 \\ 0,57 \\ 0,57 \\ 0,57 \\ 0,57 \\ 0,57 \\ 0,57 \\ 0,57 \\ 0,57 \\ 0,57 \end{array} \right\} \begin{array}{l} +0,2 \\ -0,4 \end{array} \left. \begin{array}{l} \\ \\ \\ \\ \\ \\ \\ \\ \\ \\ \end{array} \right\} \begin{array}{l} +0,007 \\ -0,015 \end{array}$	0,35	0,013	13,2	0,519	
	XGA..	3,2	11,43	0,6	2,14	15,75	0,62	14,7		0,57	0,15	0,006	13,2	0,519
	XGM..	2	7,14	0,5	1,79	15,6	0,61	14,5		0,57	0,35	0,013	13,7	0,539
	XGO..	1,2	4,29	0,1	0,36	15,6	0,61	14,5		0,57	0,35	0,013	13,7	0,539
	XGK..	1,5	5,36	0,2	0,71	15,75	0,62	14,7		0,57	0,35	0,013	13,2	0,519
	XGB..	1,5	5,36	0,3	1,07	15,75	0,62	14,7		0,57	0,15	0,006	13,2	0,519
	XGC..	0,8	2,86	0,1	0,36	15,75	0,62	14,7		0,57	0,15	0,006	13,2	0,519
	XGH..	0,45	1,61	0,05	0,18	15,6	0,61	14,5		0,57	0,35	0,013	13,7	0,539
	XGT	3,2	11,43	0,6	2,14	15,75	0,62	14,7		0,57	0,15	0,006	13,2	0,519
	XGD..	1,7	6,07	0,15	0,54	15,75	0,62	14,7		0,57	0,15	0,006	13,2	0,519
	XGG..	3,2	11,43	0,36	1,29	16,5	0,64	15,1	$\left. \begin{array}{l} 0,59 \\ 0,59 \\ 0,59 \\ 0,59 \\ 0,59 \\ 0,59 \\ 0,59 \\ 0,59 \end{array} \right\} \pm 0,5 \left. \begin{array}{l} \\ \\ \\ \\ \\ \\ \\ \end{array} \right\} \pm 0,019$	0,4	0,015	14	0,551	
	XGA..	3,2	11,43	0,54	1,93	16,5	0,64	15,1		0,59	0,2	0,007	14	0,551
	XGM..	2	7,14	0,45	1,61	16,5	0,64	15		0,59	0,4	0,015	14,4	0,566
	XGO..	1,2	4,29	0,09	0,34	16,5	0,64	15		0,59	0,4	0,015	14,4	0,566
	XGK..	1,5	5,36	0,18	0,64	16,5	0,64	15,1		0,59	0,4	0,015	14	0,551
	XGB..	1,5	5,36	0,27	0,96	16,5	0,64	15,1		0,59	0,2	0,007	14	0,551
	XGC..	0,8	2,86	0,09	0,32	16,5	0,64	15,1		0,59	0,2	0,007	14	0,551
	XGH..	0,45	1,61	0,04	0,14	16,5	0,64	15		0,59	0,4	0,015	14,4	0,566
Width of lever 7 mm/0,28 in – also available with width 4 mm/0,16 in														
	XGG..	2,6	9,29	0,32	1,14	19,2	0,75	17,5	$\left. \begin{array}{l} 0,68 \\ 0,68 \\ 0,68 \\ 0,68 \\ 0,68 \\ 0,68 \\ 0,68 \\ 0,68 \end{array} \right\} \pm 0,7 \left. \begin{array}{l} \\ \\ \\ \\ \\ \\ \\ \end{array} \right\} \pm 0,027$	0,45	0,017	16,4	0,645	
	XGA..	2,6	9,29	0,48	1,71	19,2	0,75	17,5		0,68	0,2	0,007	16,4	0,645
	XGM..	1,65	5,89	0,4	1,43	19,2	0,75	17,3		0,68	0,45	0,017	16,9	0,665
	XGO..	1	3,57	0,08	0,29	19,2	0,75	17,3		0,68	0,45	0,017	16,9	0,665
	XGK..	1,25	4,46	0,16	0,57	19,2	0,75	17,5		0,68	0,45	0,017	16,4	0,645
	XGB..	1,25	4,46	0,24	0,86	19,2	0,75	17,5		0,68	0,2	0,007	16,4	0,645
	XGC..	0,65	2,32	0,08	1,29	19,2	0,75	17,5		0,68	0,2	0,007	16,4	0,645
	XGH..	1,37	1,32	0,04	0,14	19,2	0,75	17,3		0,68	0,45	0,017	16,9	0,665
Width of lever 7 mm/0,28 in														
	XGG..	3,2	11,43	0,38	1,36	21,8	0,85	20,5	$\left. \begin{array}{l} 0,81 \\ 0,81 \\ 0,81 \\ 0,81 \\ 0,81 \\ 0,81 \\ 0,81 \\ 0,81 \end{array} \right\} \pm 0,6 \left. \begin{array}{l} \\ \\ \\ \\ \\ \\ \\ \end{array} \right\} \pm 0,023$	0,4	0,015	19,5	0,767	
	XGA..	3,2	11,43	0,85	3,04	21,8	0,85	20,5		0,81	0,2	0,007	19,5	0,767
	XGM..	2	7,14	0,48	1,71	21,8	0,85	20,3		0,8	0,4	0,015	19,8	0,779
	XGO..	1,2	4,29	0,09	0,32	21,8	0,85	20,1		0,81	0,4	0,015	19,8	0,779
	XGK..	1,5	5,36	0,19	0,68	21,8	0,85	20,5		0,81	0,4	0,015	19,5	0,767
	XGB..	1,5	5,36	0,29	1,04	21,8	0,85	20,5		0,81	0,2	0,007	19,5	0,767
	XGC..	0,8	2,86	0,09	0,32	21,8	0,85	20,5		0,81	0,2	0,007	19,5	0,767
	XGH..	0,45	1,61	0,04	0,14	21,8	0,85	20,3		0,8	0,4	0,015	19,8	0,779
Width of lever 7 mm/0,28 in														
	XGG..	3,2	11,43	0,37	1,32	21,8	0,85	20,2	$\left. \begin{array}{l} 0,79 \\ 0,79 \\ 0,79 \\ 0,79 \\ 0,79 \\ 0,79 \\ 0,79 \\ 0,79 \end{array} \right\} \pm 0,7 \left. \begin{array}{l} \\ \\ \\ \\ \\ \\ \\ \end{array} \right\} \pm 0,027$	0,4	0,015	19,3	0,759	
	XGA..	3,2	11,43	0,56	2	21,8	0,85	20,2		0,79	0,2	0,007	19,3	0,759
	XGM..	2	7,14	0,47	1,68	21,8	0,85	20,1		0,79	0,4	0,015	19,7	0,775
	XGO..	1,2	4,29	0,09	0,32	21,8	0,85	20,1		0,79	0,4	0,015	19,7	0,775
	XGK..	1,5	5,36	0,18	0,64	21,8	0,85	20,2		0,79	0,4	0,015	19,3	0,759
	XGB..	1,5	5,36	0,28	1	21,8	0,85	20,2		0,79	0,2	0,007	19,3	0,759
	XGC..	0,8	2,86	0,09	0,32	21,8	0,85	20,2		0,79	0,2	0,007	19,3	0,759
	XGH..	0,45	1,61	0,04	0,14	21,8	0,85	20,1		0,79	0,4	0,015	19,7	0,775
Width of roller 6,6 mm/0,26 in														
	XGG..	3,2	11,43	0,37	1,32	21,8	0,85	20,2	$\left. \begin{array}{l} 0,79 \\ 0,79 \\ 0,79 \\ 0,79 \\ 0,79 \\ 0,79 \\ 0,79 \\ 0,79 \end{array} \right\} \pm 0,7 \left. \begin{array}{l} \\ \\ \\ \\ \\ \\ \\ \end{array} \right\} \pm 0,027$	0,4	0,015	19,3	0,759	
	XGA..	3,2	11,43	0,56	2	21,8	0,85	20,2		0,79	0,2	0,007	19,3	0,759
	XGM..	2	7,14	0,05	1,68	21,8	0,85	20,1		0,79	0,4	0,015	19,7	0,775
	XGO..	1,2	4,29	0,09	0,32	21,8	0,85	20,1		0,79	0,4	0,015	19,7	0,775
	XGK..	1,5	5,36	0,18	0,64	21,8	0,85	20,2		0,79	0,4	0,015	19,3	0,759
	XGB..	1,5	5,36	0,28	1	21,8	0,85	20,2		0,79	0,2	0,007	19,3	0,759
	XGC..	0,8	2,86	0,09	0,32	21,8	0,85	20,2		0,79	0,2	0,007	19,3	0,759
	XGH..	0,45	1,61	0,04	0,14	21,8	0,85	20,1		0,79	0,4	0,015	19,7	0,775
Width of roller 6,6 mm/0,26 in														

¹⁾ Lever distance 8,2 (0,32) for lever position –.20, lever position (-J20, L20, S20, M20)
Lever distance 14,0 (0,55) for lever position –.40, lever position (-J40, L40, S40, M40)

²⁾ 2,65 mm for switch type XGH, XGO, XGM

³⁾ For high temperature T125°C/T 150°C (ENEC, UL)

Ordering Reference

Basic type	XGG..	3,2 N	11,43 ozf	Example: XGG	4	2	A	-88	J20	Z1
	XGA..	3,2 N	11,43 ozf							
	XGM..	2,0 N	7,14 ozf							
	XGO..	1,2 N	4,29 ozf							
	XGK..	1,5 N	5,36 ozf							
	XGB..	1,5 N	5,36 ozf							
	XGC..	0,8 N	2,86 ozf							
	XGH..	0,45 N	1,61 ozf							
	XGD..	1,7 N	6,07 ozf							
	XGT..	3,2 N	11,43 ozf							
Circuit	No symbol, change-over (CO)									
4	Normally closed (NC)									
5	Normally open (NO)									
Terminals	2	Faston	6,3 × 0,8							
	3	Solder	1,7 × 3,2							
	4	Faston	1 × 2,8 × 0,5 DIN							
	5	Faston	1 × 2,8 × 0,5							
	6	Faston	4,8 × 0,5							
	10	Faston	4,8 × 0,8							
	12	Short solder	∅ 2,3							
	13	Print bent (lid)								
	14	Print bent (base)								
	15	Rast 5	6,3 × 0,8							
	19	Short solder	∅ 1,7							
Other types of terminals are available on request										
Version	ENEC		Number of operations at rated load							
	No symbol, T85		UL	Europe	UL					
A	T85		T90	50,000	6,000					
W	T150		T150	50,000	6,000					
AW	T150		T150	50,000	100,000					
B	T85		T90	10,000	6,000					
V	T125		T130	50,000	6,000					
AV	T125		T130	50,000	100,000					
C	T85		T90	25,000	6,000					
Contacts	-88	Ag / AgNi10								
	-81	Gold-plated 2 µm (Au) on Ag								
	-86	Ag / Ag CdO								
Actuators	No symbol, plunger									
	J20 ¹⁾	J40 ²⁾	Plain lever	13,5 mm						
	J22 ¹⁾	J42 ²⁾	Plain lever	24,0 mm						
	J23 ¹⁾	J43 ²⁾	Plain lever	27,8 mm						
	J27 ¹⁾	J47 ²⁾	Plain lever	60,0 mm						
	M20 ¹⁾	M40 ²⁾	Plain lever formed	14,7 mm						
	L20 ¹⁾	L40 ²⁾	Cam follower	12,8 mm						
	L21 ¹⁾	L41 ²⁾	Cam follower	26,2 mm						
	S20 ¹⁾	S40 ²⁾	Roller lever	12,8 mm						
	T20 ¹⁾	T40 ²⁾	Roller lever, 150°C version	12,8 mm						
Other actuators available on request										
¹⁾ Lever distance 8,2 (0,32) for lever position –20, lever position (–J20, L20, S20, M20)										
²⁾ Lever distance 14,0 (0,55) for lever position –40, lever position (–J40, L40, S40, M40)										
Approvals	No symbol, ENEC									
	Z1	UL, CSA								